

# HYDROTEC

TREE PROTECTION

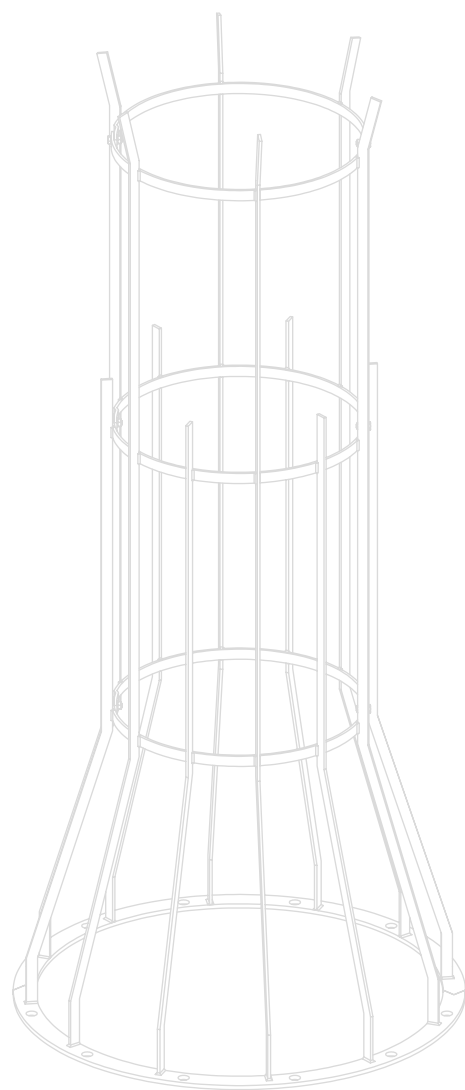
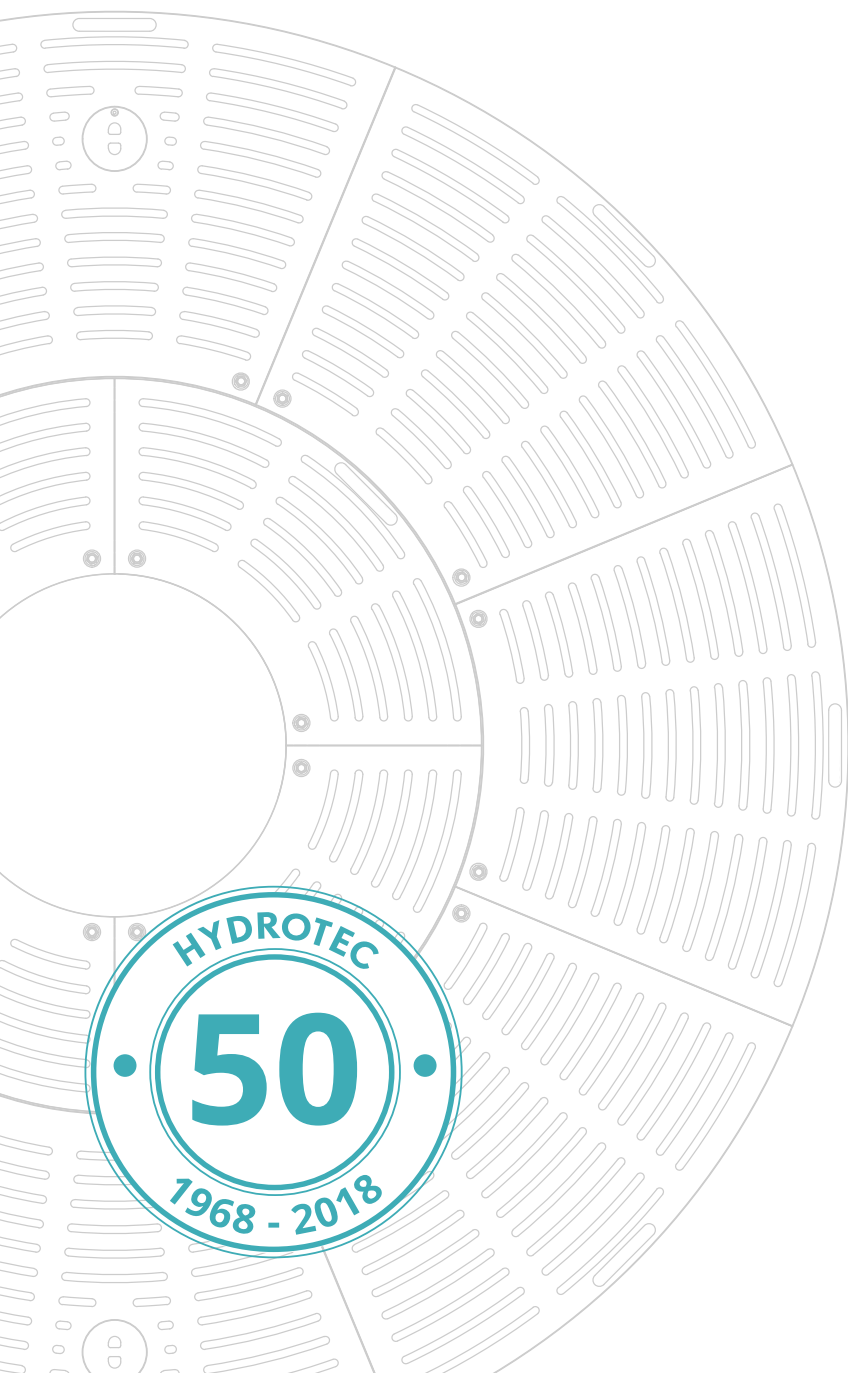

## CONTENT

About HYDROTEC .....	3
Why tree protection? .....	4
Tree protection system .....	5
Coatings .....	6

### TREE GRATES

Product benefits .....	8
Tree grates - Ray shaped-/Radial design .....	10
Tree grates - Linear-/Quadro design .....	14
Tree grates with spotlights .....	16
Tree grates with removable inner part .....	18
Tree grates - Special solutions .....	20

### SUPPORT FRAMES, CONCRETE FOUNDATIONS

Product benefits .....	22
Support frame 15 kN .....	24
Support frame 50 kN .....	25
Concrete foundations .....	26

### TREE GUARDS, TRELIS, COLLISION PROTECTION

Product benefits .....	28
Tree guards .....	30
Tree guards - upper part .....	33
Trellis .....	34
Collision protection .....	35

## ABOUT HYDROTEC



### From little to large.

On reflection, we consider this company to be a success story.



When starting out nearly 50 years ago not even the company's founder, [Gisbert Brinkschulte](#), could have envisioned that his sole ownership company would grow to be such a strong global player namely HYDROTEC Technologies AG. The company has grown with a comprehensive network of business partners

and is taking all necessary steps to continue growing in the future. HYDROTEC products are sold in many different countries and seek to establish ourselves as one of the leading players in each market. To achieve this we adhere to our principles: High quality products at fair market prices.

### We like to answer your questions before you ask them.

With our commitment to continually improve our technology and broaden our range of quality products HYDROTEC is expanding its core business which is manufacturing and selling drainage castings / systems. Self-leveling manhole covers, drainage channels, surface boxes, or street furniture are just a few examples of our product portfolio, which is sold all over the world.

### It is not just a question of business, but of people who understand our business.

Our staff at HYDROTEC strive to find the best possible solution for our customers every day. We have a simple recipe for giving you the information you need: Responsibility. Employees who identify themselves with their jobs are motivated and put 100% into their jobs. This helps us and above all our customers.

### Single-source supplier.

Business means change. We understand each change primarily as an opportunity. This is why we don't just monitor the market status quo. Instead we think about tomorrow's market needs. New ideas on the one hand and our enormous import and export experience on the other: this symbiosis holds enormous potential for the successful future development of HYDROTEC.



## WHY TREE PROTECTION?



### Why are trees important for our cities?

- Trees improve the climate.
- Trees clean the air.
- Trees create a more beautiful cityscape.
- Trees form green zones to relax and unwind.
- Trees provide shade.
- Trees dampen the noise of the streets.

### Why tree protection?

Trees with their many advantages are exposed to some negative influences in urban areas:

- sealed floors that affect the air and water supply
- collision damage that injures the tree trunk

The HYDROTEC tree protection system ensures effective tree protection.

# HYDROTEC TREE PROTECTION SYSTEM

- 1 Tree guards made of hot-dip galvanised steel (from page 28)
- 2 Tree grates made of ductile iron (from page 8)
- 3 Support frames made of hot-dip galvanised steel (from page 22)
- 4 Concrete foundation (from page 22)

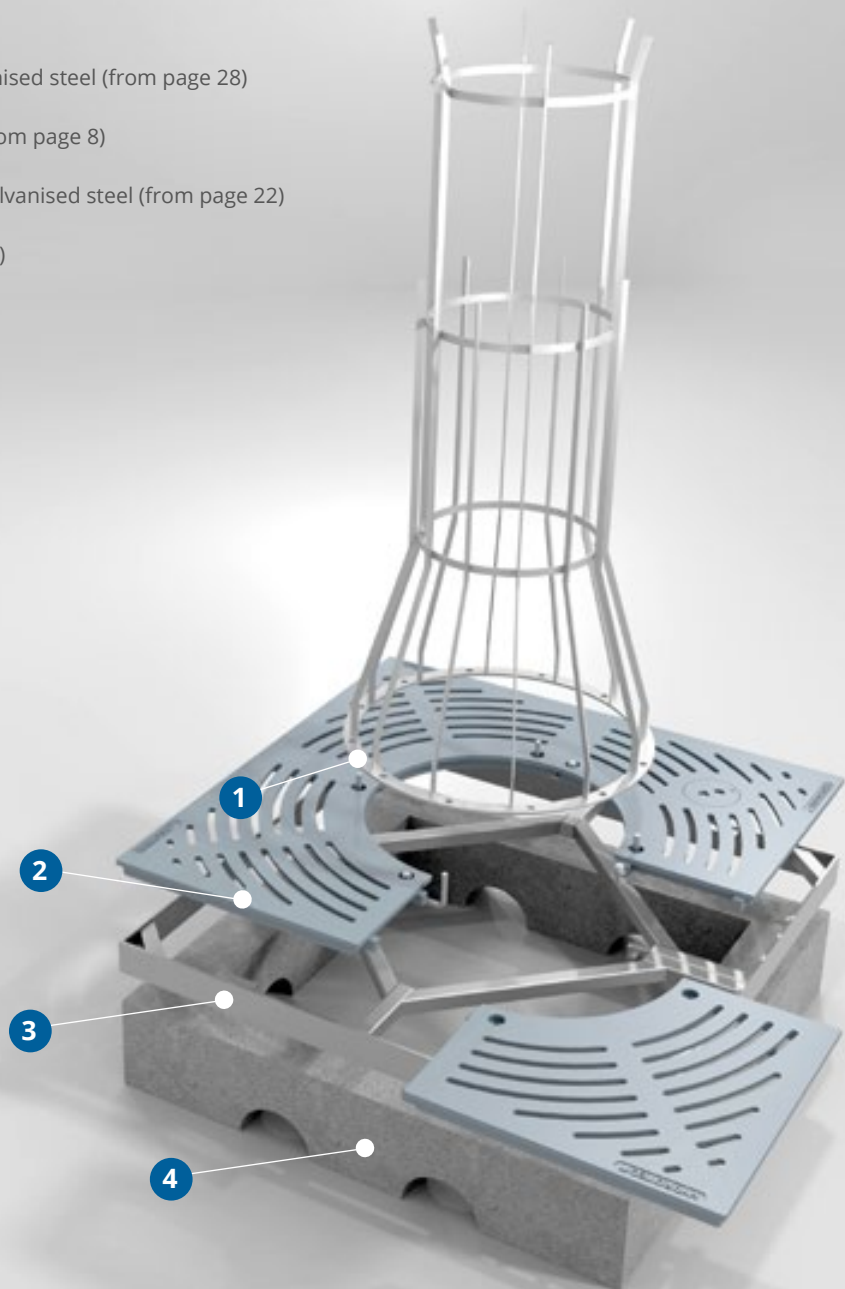

## COATINGS



Natural



Powder-coating

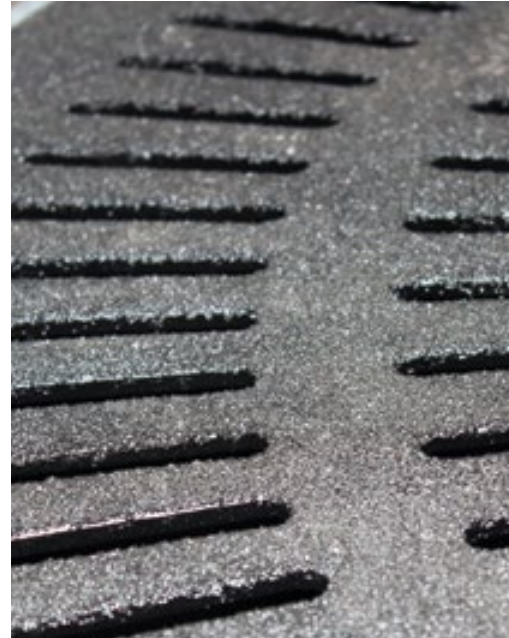

Anti-slip-coating

### Natural

Without coating

- ✔ Environmentally friendly

### Powder-coating

Polyester and epoxy resin mixture, color black RAL 9005

- ✔ Dense, durable, structured coating
- ✔ Highest corrosion protection
- ✔ High mechanical resistance
- ✔ High resistance to weathering
- ✔ Good antibacterial properties
- ✔ Environmentally friendly
- ✔ High UV protection
- ✔ All RAL and DB colors possible

### Anti-slip-coating

A special 2K-EP thick-film lacquering with granules including sealing with anti-slip effect.

# TREE PROTECTION SYSTEMS



Tree grates - from page 8



Tree guards - from page 28



Collision protection with tree guard upper part - from page 28

# TREE GRATES

Product benefits

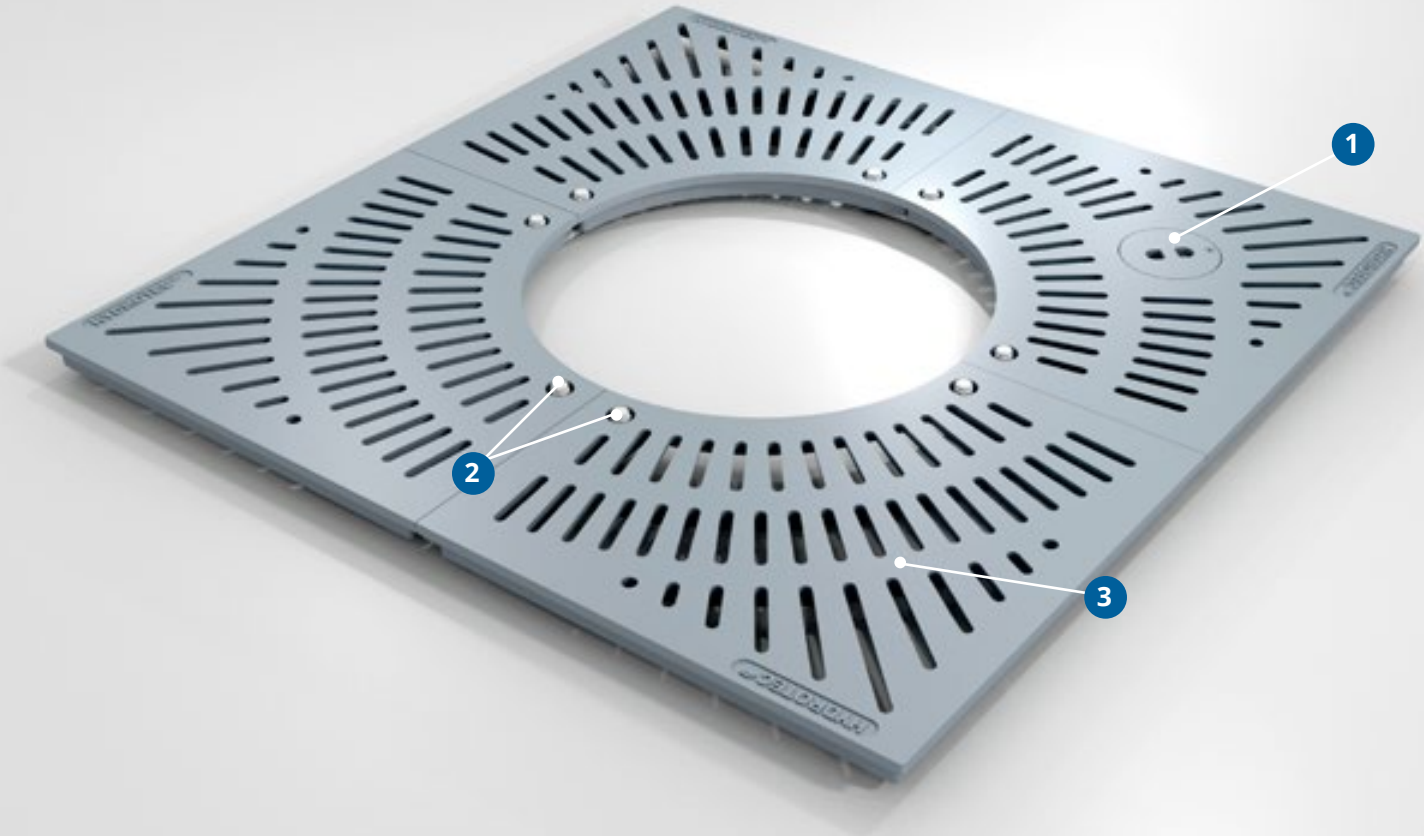

# TREE GRATES

## Product benefits



### Test load 15 kN to 50 kN

Depending on the type of substructure (support frames), the tree grates can withstand a load of 15 kN to 50 kN.

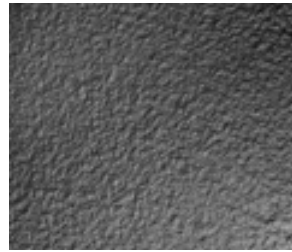

### Tree grates made of ductile iron

Ductile iron (ductile iron with nodular graphite) is robust, can withstand high static loads and has high corrosion resistance.



### Root protection

The tree grates protect the soil around the tree from excessive compaction and relieve the root system.



### Natural water and air exchange

Slots in the tree grate allow rainfall to seep away without any problems and ensure optimum air exchange.



1

### Irrigation opening

Drainages are laid along the roots for optimal watering of the tree. The irrigation opening provides easy access.



2

### Simple maintenance

Significantly easier maintenance due to segments bolted from above.



3

### Installation & transport

Tree grates are divided into individual segments, which simplify the transport and installation.



3

### Designs

- Ray shaped design
- Radial design
- Linear design
- Quadro design
- with spotlights
- with removable inner part
- for special solutions

# TREE GRATES

## Ray shaped design - square

Art. No.	Designation	L mm	d mm	H mm	Segments	approx. kg total
----------	-------------	------	------	------	----------	------------------

### Ray shaped design - square

4612506061	AQD 125/60	1250	600	41	4	116
4615007061	AQD 150/70	1500	700	41	4	160
4618007061	AQD 180/70	1800	700	41	8	228
4620007061	AQD 200/70	2000	700	46	8	296
4620012568 <sup>1</sup>	AQD 200/125	2000	1250	41	4	200
4625007061 <sup>1</sup>	AQD 250/70	2500	700	46	8	580
4630008061 <sup>1,2</sup>	AQD 300/80	3000	800	46	8	826
4630015061 <sup>1,2</sup>	AQD 300/150	3000	1500	41	8	650

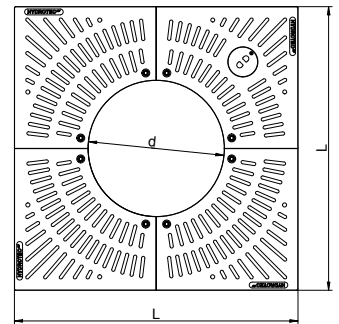
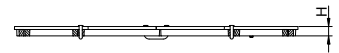
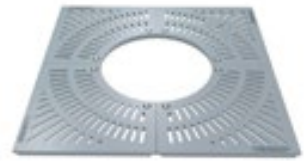

# TREE GRATES

## Radial design - square

Art. No.	Designation	L mm	d mm	H mm	Segments	approx. kg total
----------	-------------	------	------	------	----------	------------------

### Radial design - square

4612506062	AQD 125/60	1250	600	41	4	119
4615007062	AQD 150/70	1500	700	41	4	152
4618007069	AQD 180/70	1800	700	41	4	220
4620007062	AQD 200/70	2000	700	46	8	312
4620007069	AQD 200/70	2000	700	46	4	287
4625007062 <sup>1</sup>	AQD 250/70	2500	700	46	8	610
4630008062 <sup>1,2</sup>	AQD 300/80	3000	800	46	8	880
4630015062 <sup>1,2</sup>	AQD 300/150	3000	1500	41	8	780

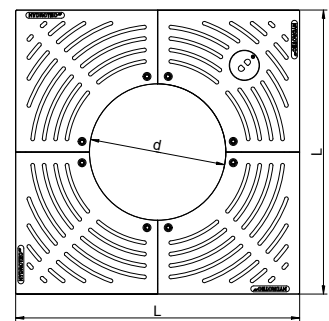
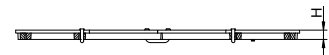

<sup>1</sup> on request

<sup>2</sup> two irrigation openings

Accessories: U-bolt M14 x 42 x 92 - Art. No. 46400819100

Tree grates are powder-coated in RAL 9005 (black), different RAL/DB colors are available on request.

# TREE GRATES

## Ray shaped design - round

Art. No.	Designation	D mm	d mm	H mm	Segments	approx. kg total
----------	-------------	------	------	------	----------	------------------

### Ray shaped design - round

4512506061	AKD 125/60	1250	600	41	4	88
4515007061	AKD 150/70	1500	700	41	4	96
4518007061	AKD 180/70	1800	700	41	6	165
4520007061	AKD 200/70	2000	700	46	6	218
4525007061 <sup>1</sup>	AKD 250/70	2500	700	46	8	400
4530008061 <sup>1,2</sup>	AKD 300/80	3000	800	46	8	616
4530015061 <sup>1,2</sup>	AKD 300/150	3000	1500	41	8	480

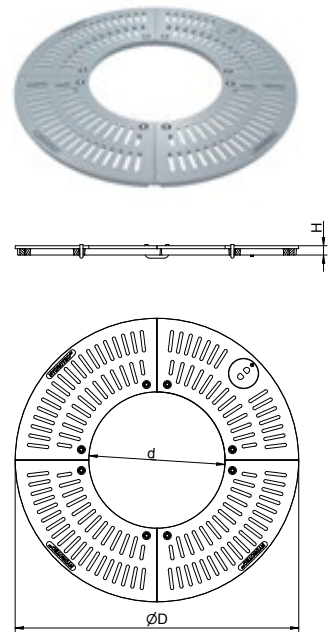

# TREE GRATES

## Radial design - round

Art. No.	Designation	D mm	d mm	H mm	Segments	approx. kg total
----------	-------------	------	------	------	----------	------------------

### Radial design - round

4512506062	AKD 125/60	1250	600	41	4	88
4515007062	AKD 150/70	1500	700	41	4	114
4520007062	AKD 200/70	2000	700	46	6	233
4525007062 <sup>1</sup>	AKD 250/70	2500	700	46	8	495
4530008062 <sup>1,2</sup>	AKD 300/80	3000	800	46	8	520
4530015062 <sup>1,2</sup>	AKD 300/150	3000	1500	41	8	480

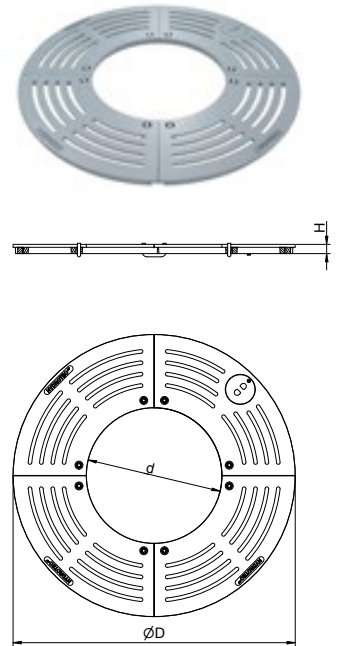

<sup>1</sup> on request

<sup>2</sup> two irrigation openings

Accessories: U-bolt M14 x 42 x 92 - Art. No. 46400819100

Tree grates are powder-coated in RAL 9005 (black), different RAL/DB colors are available on request.

# TREE GRATES

## Linear design

Art. No.	Designation	L mm	I mm	H mm	Segments	approx. kg total
----------	-------------	------	------	------	----------	------------------

**Linear design**

4315007069 <sup>1</sup>	AQD 150/70	1500	700	41	4	164
4320007069 <sup>1</sup>	AQD 200/70	2000	700	46	4	364

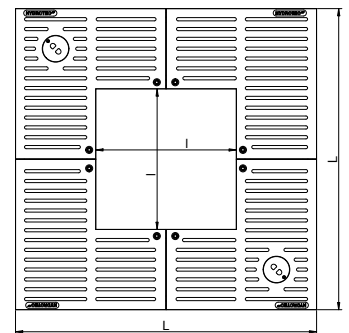
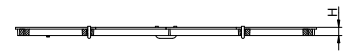

# TREE GRATES

## Quadro design

Art. No.	Designation	L mm	I mm	H mm	Segments	approx. kg total
----------	-------------	------	------	------	----------	------------------

**Quadro design**

4315007068	AQD 150/70	1500	700	41	4	168
4320008068	AQD 200/80	2000	800	46	4	326

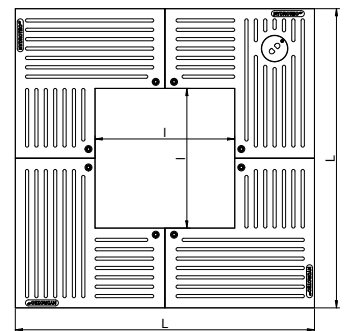
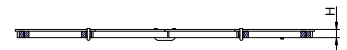
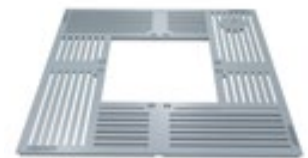

# TREE GRATES

## With spotlights - square

Art. No.	Designation	D mm	d mm	H mm	Position spotlights	Segments	Number spotlights
----------	-------------	------	------	------	---------------------	----------	-------------------

### Ray shaped design - square

4615007063	AQD 150/70	1500	700	41	corner	4	1-4 <sup>1</sup>
4618007063	AKD 180/70	1800	700	41	centric	8	1-4
4620007063	AQD 200/70	2000	700	46	centric	8	1-4

### Radial design - square

4615007064	AQD 150/70	1500	700	41	corner	4	1-4 <sup>1</sup>
4620007064	AQD 200/70	2000	700	46	centric	8	1-4

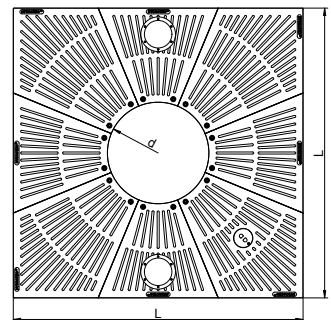
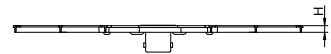

All listed tree guards use BEGA spotlights ([www.bega.de](http://www.bega.de)).

16 <sup>1</sup> With 4-part tree grates with 4 spotlights are no irrigation openings possible.

Tree grates are powder-coated in RAL 9005 (black), different RAL/DB colors are available on request.

Accessories: U-bolt M14 x 42 x 92 - Art. No. 46400819100

# TREE GRATES

## With spotlights - round

Art. No.	Designation	D mm	d mm	H mm	Position spotlights	Segments	Number spotlights
----------	-------------	------	------	------	---------------------	----------	-------------------

### Ray shaped design - round

4515007063	AKD 150/70	1500	700	41	centric	4	1-4 <sup>1</sup>
4518007063	AKD 180/70	1800	700	41	centric	6	1-4
4520007063	AKD 200/70	2000	700	46	centric	6	1-4

### Radial design - round

4515007064	AKD 150/70	1500	700	41	centric	4	1-4 <sup>1</sup>
4520007064	AKD 200/70	2000	700	46	centric	6	1-4

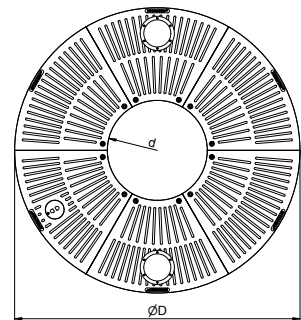
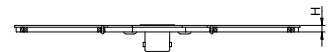

All listed tree guards use BEGA spotlights ([www.bega.de](http://www.bega.de)).

<sup>1</sup> With 4-part tree grates with 4 spotlights are no irrigation openings possible.

Tree grates are powder-coated in RAL 9005 (black), different RAL/DB colors are available on request.

Accessories: U-bolt M14 x 42 x 92 - Art. No. 46400819100

# TREE GRATES

## With removable inner part - square

Art. No.	Designation	L mm	dm mm	d mm	H mm	Segments
----------	-------------	---------	----------	---------	---------	----------

**Ray shaped design - square**

4620126061 <sup>1</sup>	AQD 200/125/60	2000	1250	600	41	8
4630157061 <sup>1</sup>	AQD 300/150/70	3000	1500	700	41	12

**Radial design - square**

4630157062 <sup>1</sup>	AQD 300/150/70	3000	1500	700	41	12
-------------------------	----------------	------	------	-----	----	----

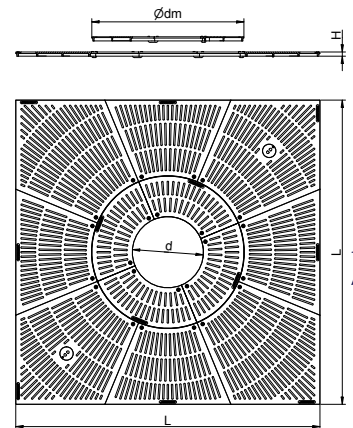
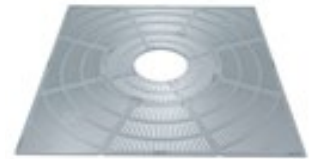

# TREE GRATES

## With removable inner part - round

Art. No.	Designation	D mm	dm mm	d mm	H mm	Segments
----------	-------------	------	-------	------	------	----------

**Ray shaped design - round**

4530157061 <sup>1</sup>	AKD 300/150/70	3000	1500	700	41	12
-------------------------	----------------	------	------	-----	----	----

**Radial design - round**

4530157062 <sup>1</sup>	AKD 300/150/70	3000	1500	700	41	12
-------------------------	----------------	------	------	-----	----	----

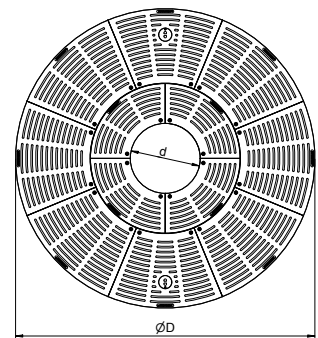
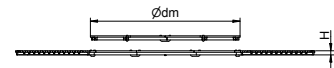

<sup>1</sup> on request

Accessories: U-bolt M14 x 42 x 92 - Art. No. 46400819100

Tree grates are powder-coated in RAL 9005 (black), different RAL/DB colors are available on request.

# TREE GRATES

## Special solutions - freely combinable

Art. No.	Designation	L mm	I mm	H mm	Segments	approx. kg total
4607006099 <sup>1,2</sup>	ARD 70/60	600	700	41	1	41
4609506099 <sup>1,2</sup>	ARD 95/60	600	950	41	1	55
4607507599 <sup>1,2</sup>	ARD 75/75	750	750	41	1	59
4610005099 <sup>1,2</sup>	ARD 50/100	1000	500	41	1	51

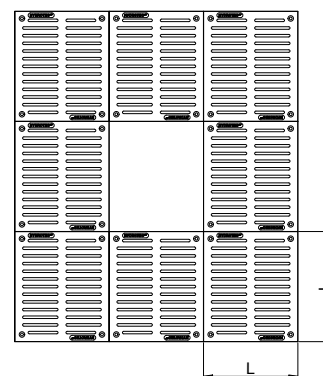

<sup>1</sup> on request      <sup>2</sup> A special substructure must be manufactured.

# TREE GRATES

Special solutions



# SUPPORT FRAMES, CONCRETE FOUNDATIONS

Product benefits

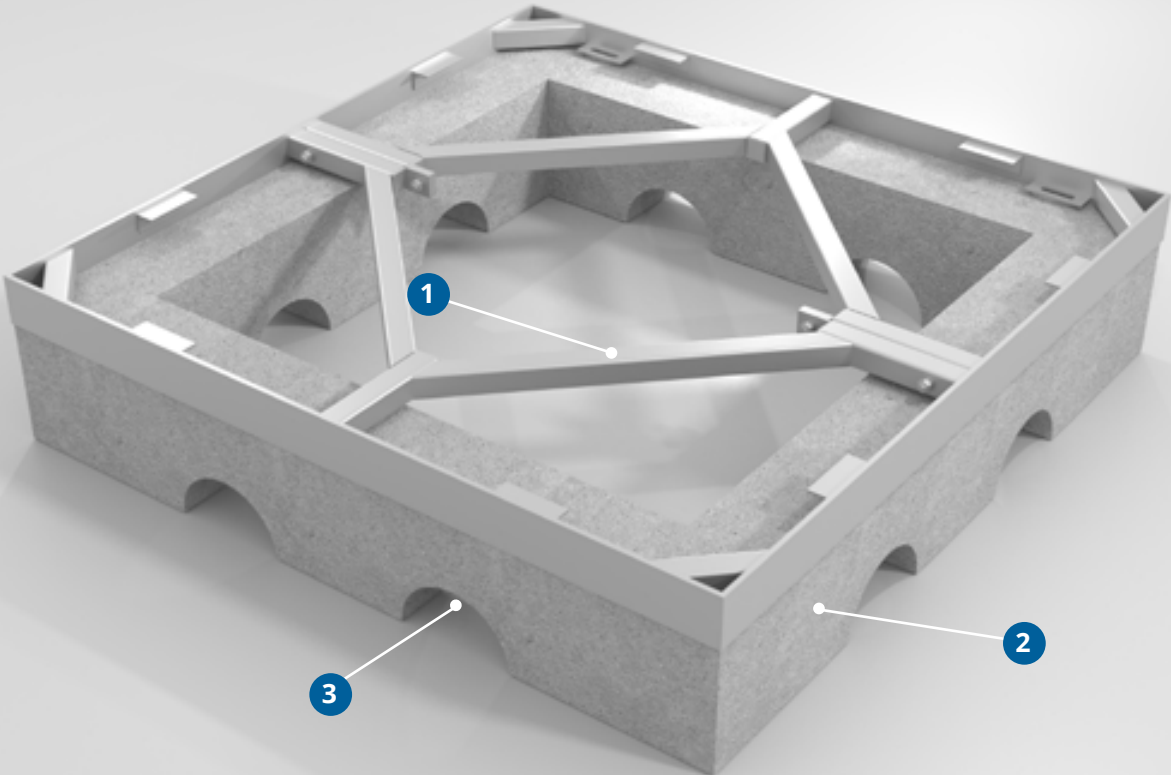

# SUPPORT FRAMES, CONCRETE FOUNDATIONS

## Product benefits

1



Support frame 15 kN

The support is a 2-part substructure, which can withstand a load of up to 15 kN.

1



Support frame 50 kN

The support is a 2-part substructure, which can withstand a load of up to 50 kN.

1



Support frames made of hot-dip galvanized steel

Steel is stable, durable and recyclable. Corrosion damage is prevented by hot-dip galvanising.

2



Concrete foundation

The concrete foundation consists of individual segments, which facilitate transport and installation.

3

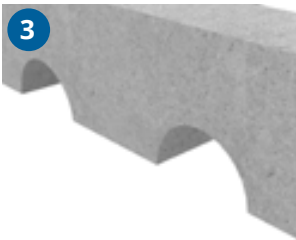

Root recesses

The recesses in the concrete foundation ensure optimum passage of the tree roots.

# SUPPORT FRAMES

## 15 kN

Art. No.	Designation	L mm	I mm	H mm	Segments	approx. kg total
----------	-------------	------	------	------	----------	------------------

### Square

4012506080	EAQ 125/60	1274	625	80	2	42
4015007080	EAQ 150/70	1524	725	80	2	50
4015007083 <sup>2</sup>	EAQ 150/70	1524	850	80	2	55
4018007080	EAQ 180/70	1824	825	80	2	64
4020007080	EAQ 200/70	2024	825	100	2	83
4020007083 <sup>2</sup>	EAQ 200/70	2024	925	100	2	135
4020012580	EAQ 200/125	2024	1275	100	2	74
4020126080	EAQ 200/125/60	2024	1275/625	80	4	111
4025007080	EAQ 250/70	2524	825	100	2	105
4030008080	EAQ 300/80	3024	925	100	2	146
4030015081	EAQ 300/150	3024	1600	100	2	160
4030157081 <sup>1</sup>	EAQ 300/150/70	3024	1600/825	100	4	215

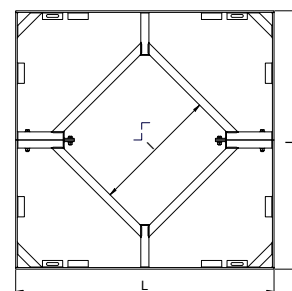

Art. No.	Designation	D mm	I mm	H mm	Segments	approx. kg total
----------	-------------	------	------	------	----------	------------------

### Round

4012506070	EAK 125/60	1274	625	80	2	36
4015007070	EAK 150/70	1524	725	80	2	43
4018007070	EAK 180/70	1824	825	80	2	51
4020007070	EAK 200/70	2024	825	100	2	66
4025007070	EAK 250/70	2524	825	100	2	83
4030008070	EAK 300/80	3024	925	100	2	98
4030015070	EAK 300/150	3024	1600	100	2	115
4030157070 <sup>1</sup>	EAK 300/150/70	3024	1600/825	100	4	180

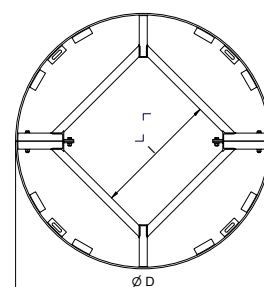
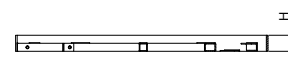

# SUPPORT FRAMES

## 50 kN

Art. No.	Designation	L mm	I mm	H mm	Segments	approx. kg total
----------	-------------	------	------	------	----------	------------------

Square						
4012506020	TAQ 125/60	1274	630	100	2	70
4015007020	TAQ 150/70	1524	730	100	2	90
4015007023 <sup>2</sup>	TAQ 150/70	1524	800	100	2	103
4018007020	TAQ 180/70	1824	800	120	2	156
4020012520	TAQ 200/125	2024	1275	100	2	148
4020126020 <sup>1</sup>	TAQ 200/125/60	2024	1360/730	120	4	200
4020007020	TAQ 200/70	2024	800	120	2	194
4020007023 <sup>2</sup>	TAQ 200/70	2024	825	120	2	198
4025007020	TAQ 250/70	2524	800	120	2	332
4030008020	TAQ 300/80	3024	900	120	2	426
4030015020	TAQ 300/150	3024	1600	120	2	402
4030157020 <sup>1</sup>	TAQ 300/150/70	3024	1600/800	120	4	482

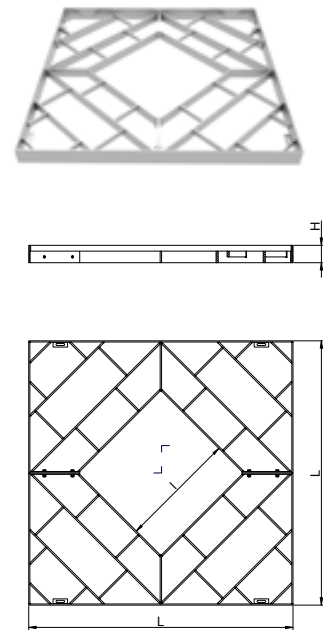

Art. No.	Designation	D mm	I mm	H mm	Segments	approx. kg total
----------	-------------	------	------	------	----------	------------------

Round						
4012506010	TAK 125/60	1274	630	100	2	54
4015007010	TAK 150/70	1524	730	100	2	65
4018007010	TAK 180/70	1824	800	120	2	122
4020007010	TAK 200/70	2024	800	120	2	144
4025007010	TAK 250/70	2524	800	120	2	254
4030008010	TAK 300/80	3024	900	120	2	315
4030015010	TAK 300/150	3024	1600	120	2	295
4030157010 <sup>1</sup>	TAK 300/150/70	3024	1600/800	120	4	355

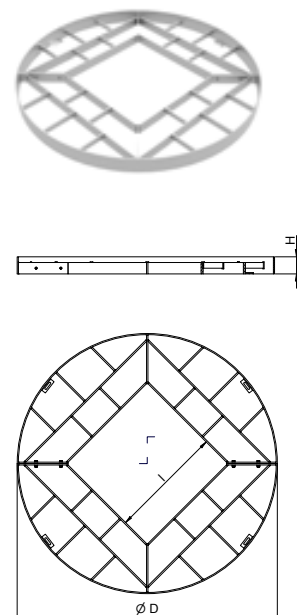

<sup>1</sup> support frame with removable inner part  
<sup>2</sup> only usable for linear- and quadro design

# CONCRETE FOUNDATIONS

## For support frames and tree grates

Art. No.	Designation	L1 mm	L2 mm	H mm	Segments	approx. kg total
----------	-------------	-------	-------	------	----------	------------------

Square						
4112560260	125/25	1350	1030	250	4	440
4112560460	125/40	1350	1030	400	4	710
4115070260	150/25	1600	1280	250	4	520
4115070460	150/40	1600	1280	400	4	840
4118070260	180/25	1900	1580	250	4	640
4118070460	180/40	1900	1580	400	4	1030
4120070260	200/25	2100	1780	250	4	700
4120070460	200/40	2100	1780	400	4	1140
4125070260	250/25	2600	2280	250	4	890
4125070460	250/40	2600	2280	400	4	1440
4130080260	300/25	3100	2780	250	4	1080
4130080460	300/40	3100	2780	400	4	1740

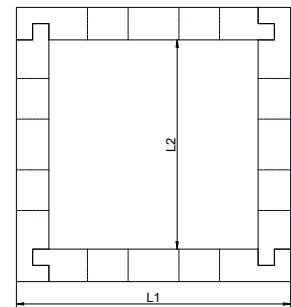
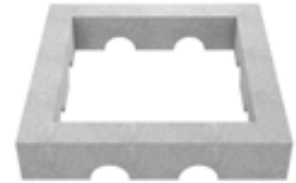

Art. No.	Designation	D1 mm	D2 mm	H mm	Segments	approx. kg total
----------	-------------	-------	-------	------	----------	------------------

Round						
4112500525	125/25	1350	1030	250	1	305
4115000525	150/25	1600	1280	250	1	368
4118000525	180/25	1900	1580	250	1	481
4120000525	200/25	2100	1780	250	1	510
4125000525	250/25	2600	2280	250	2	630
4130000525	300/25	3100	2780	250	4	765

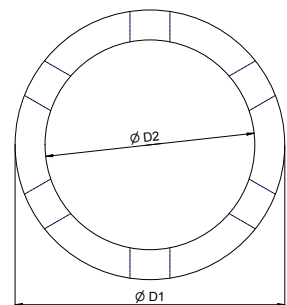

# TREE GRATES



Tree grates - linear design - from page 14



Tree grates for special solutions - from page 20



Tree grates - ray shaped design - from page 10

# TREE GUARDS, TRELLIS, COLLISION PROTECTION

Product benefits

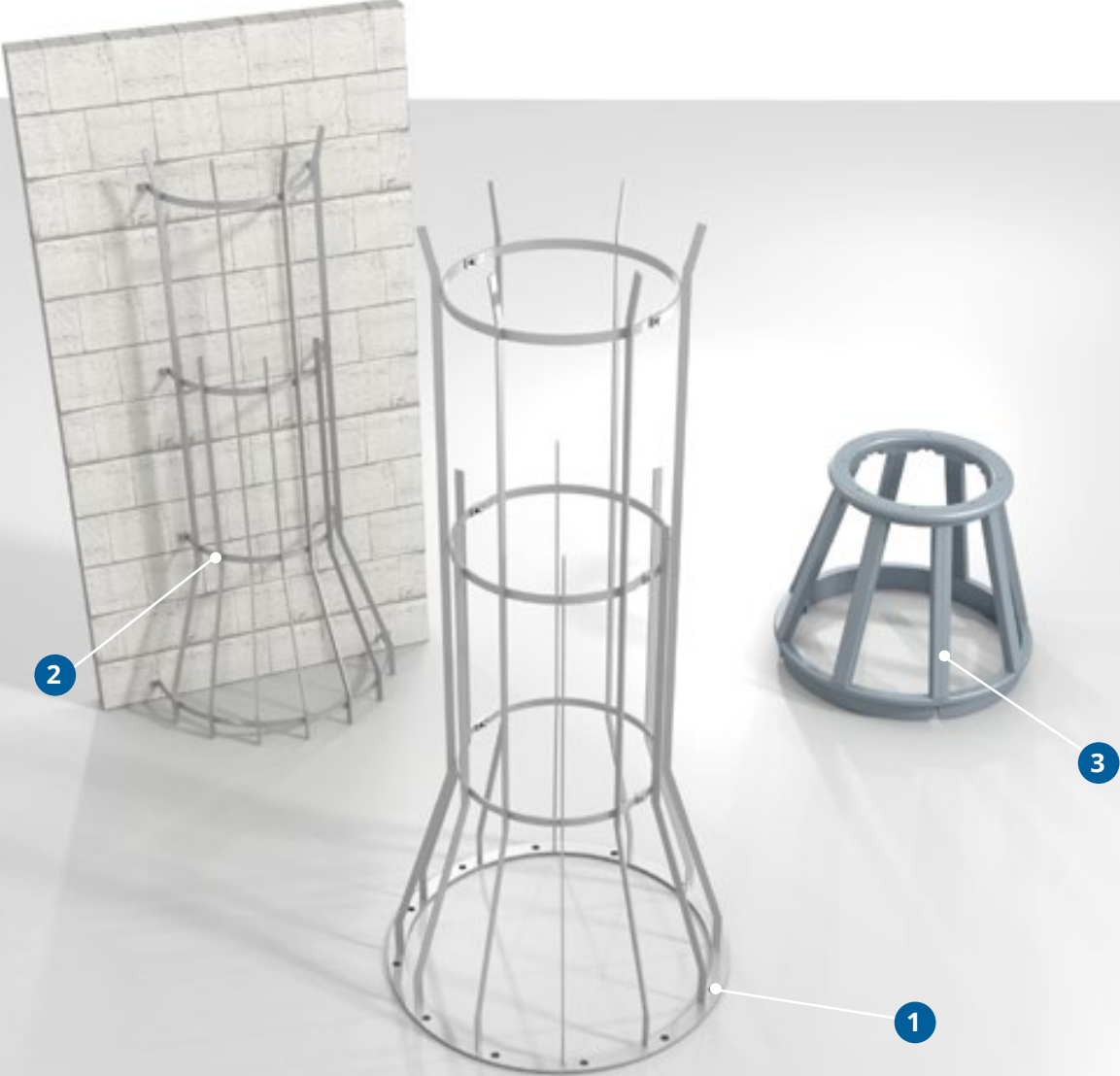

# TREE GUARDS, TRELIS, COLLISION PROTECTION

## Product benefits



### Trunk protection

Tree guards protect the trunk area of the tree from collision damage and minor damage, for example from leaning bicycles.



Tree guards made of hot-dip galvanized steel

Steel is stable, durable and recyclable. Corrosion damage is prevented by hot-dip galvanising.



### Stabilisation

Tree guards can help to stabilise the growth phase of the tree.

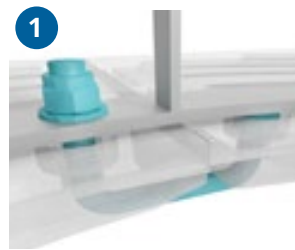

### Mounting on tree grating segments

The tree guard is bolted to the tree grating segments with special U-bolts and thus maintains a stable standing.



### Variations

Tree guards are available in different designs.



### Trellis

Perfect protection for plants growing on house walls.



### Collision protection

The collision protection made of ductile iron is a better protection against external damage and can be completed by a tree guard - upper part.

# TREE GUARDS

## Type-A

Art. No.	Designation	N mm	D mm	H mm	approx. kg total
4918275509	Type-A1	Ø 700	Ø 500	1820	26
4913870400	Type-A2	Ø 700	Ø 400	1380	21
4918265409	Type-A3	Ø 600	Ø 400	1820	25
4912675509	Type-A4	Ø 700	Ø 500	1260	23
4918275309	Type-A5	Ø 700	Ø 300	1820	31
4918285509	Type-A6	Ø 800	Ø 500	1820	28
4918275515	Type-A7	Ø 700	Ø 700	1820	30
4918275514	Type-A8	Ø 700	Ø 500	1820	35
4918275511	Type-A9	□ 700	Ø 500	1820	31

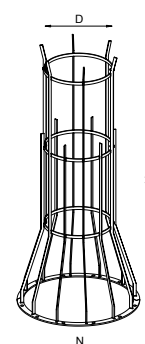

# TREE GUARDS

## Type-B

Art. No.	Designation	N mm	D mm	H mm	approx. kg total
4918275500	Type-B1	Ø 700	Ø 500	1820	34
4918275510	Type-B2	Ø 700	Ø 500	1820	43
4918265510	Type-B3	Ø 600	Ø 500	1820	41

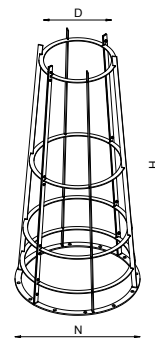

RAL/DB colors are available on request.

Accessories: U-bolts for tree grates with tree guards M14 x 42 x 140 x 92 - Art. No. 46400819200

# TREE GUARDS

## Type-C

Art. No.	Designation	N mm	D mm	H mm	approx. kg total
4918275513	Type-C1	Ø 700	Ø 500	1820	62
4918275512	Type-C2	□ 700	Ø 500	1820	64

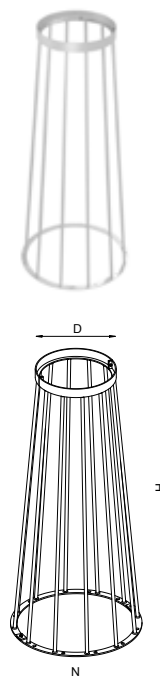

# TREE GUARDS - UPPER PART

## Type-D

Art. No.	Designation	N mm	D mm	H mm	approx. kg total
4912640301	Type-D1	Ø 400	Ø 300	1260	18
4912640302	Type-D2	Ø 400	Ø 300	1260	30
4912640403	Type-D3	Ø 400	Ø 400	1260	14
4912640404	Type-D4	Ø 400	Ø 400	1260	21
4912640405	Type-D5	Ø 400	Ø 400	1260	19
4912640406	Type-D6	Ø 400	Ø 400	1260	21

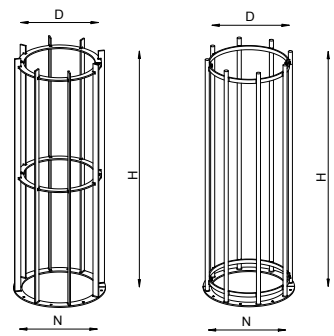
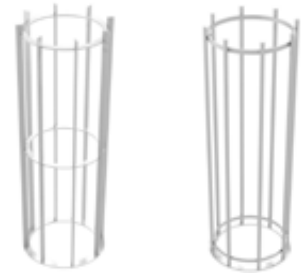

Type-D4

Type-D6



# TRELLIS

## Type-E

Art. No.	Designation	N mm	D mm	H mm	approx. kg total
4918275519	Type-E1	Ø 700	Ø 460	1820	14
4918275520	Type-E2	Ø 700	Ø 460	620	6
4918275518	Type-E3	Ø 700	Ø 350	1820	16

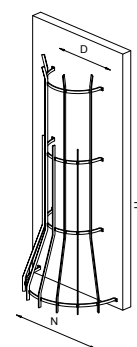
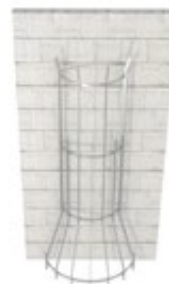

# COLLISION PROTECTION

## Type-F

Art. No.	Designation	S mm	N mm	D mm	H mm	approx. kg total
----------	-------------	------	------	------	------	------------------

4805670407	Type-F	50	Ø 700	Ø 400	500	81
------------	--------	----	-------	-------	-----	----

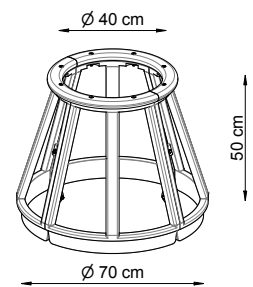



HYDROTEC Technologies AG  
Düngstruper Strasse 46  
27793 Wildeshausen  
Germany

 [office@hydrotec.com](mailto:office@hydrotec.com)

 [www.hydrotec.com](http://www.hydrotec.com)

 +49 4431 9355-0

 +49 4431 9355-22